

SCULPTURE



What are the two most basic types of sculpture?



Relief



In the Round



What materials can be used for sculpture?

{The list is as infinite as our imaginations.}

Metal Sculpture:

- wire
- pipecleaners
- metal foil (heavy aluminum + copper)
- light aluminum foil

Clay Sculpture:

- There are many different kinds of clay. (Even home made)

Reuse Sculpture:

- All sorts of found objects.
- cardboard (any shape and size)
- boxes, cans, and containers
- plastic items
- styrofoam
- wood

Environmental 3-D:

- the earth, rocks, sand
- outdoor sculpture

SCULPTURE

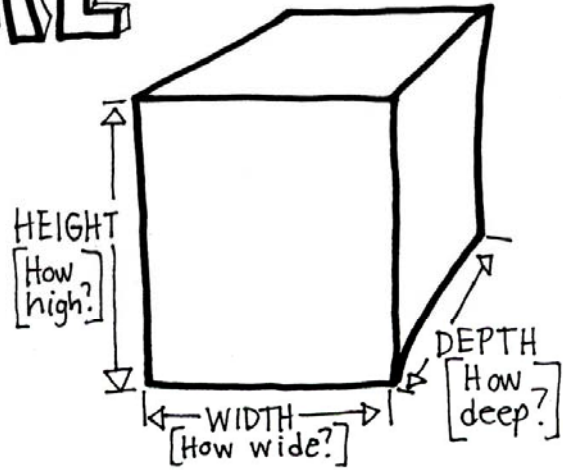
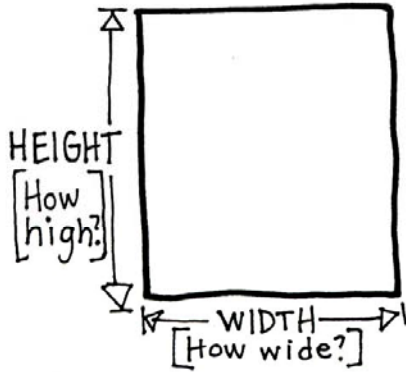

2-D IMENSIONS VS 3-D IMENSIONS

Shape Δ VS FORM 



VS



Sticks
Out

Sculpture = (noun) a work of art in three dimensions (relief and in the round).

Sculptor = (noun) one, an artist who makes sculpture.

Sculpt = (verb) fashion, carve, cut, hew, chisel, shape, form, model, make, or manipulate using the techniques of sculpture.

(2D) Two Dimensional Shapes

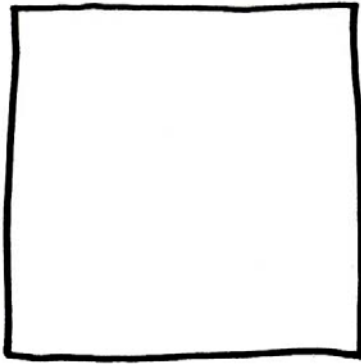

Square

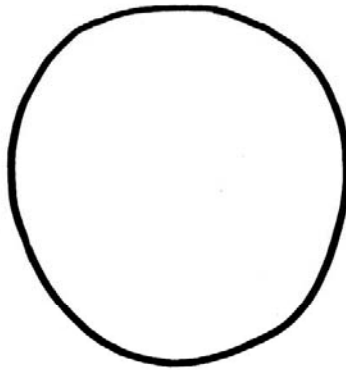

Circle

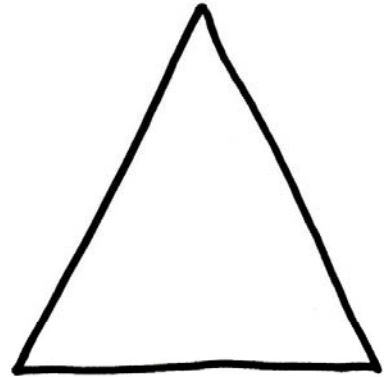

Triangle



What are the two dimensions?

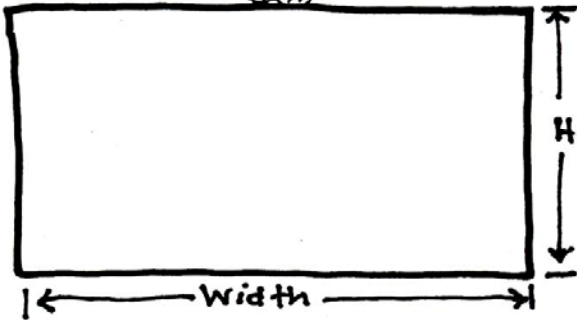

Rectangle



Quadrangle
(Quadrilateral)

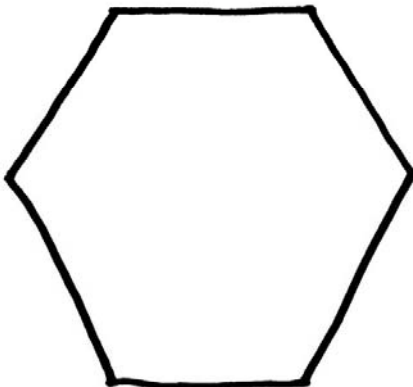

Hexagon

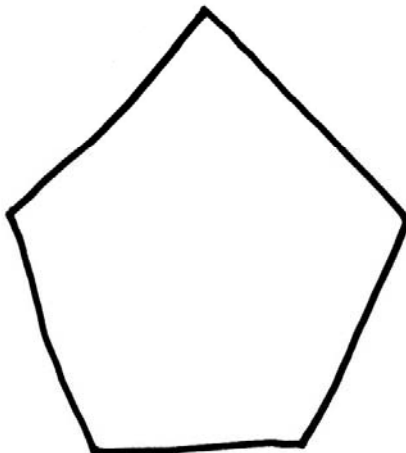

Pentagon

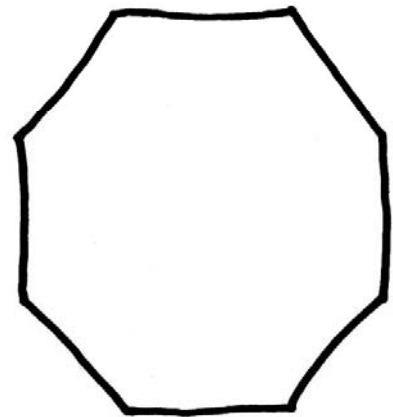

Octagon

(3-D) Three Dimensional Forms

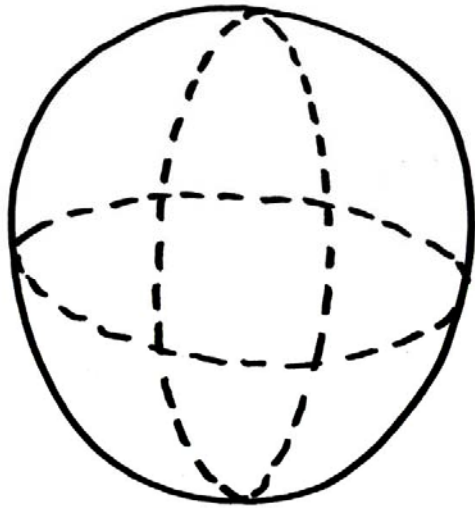

Sphere

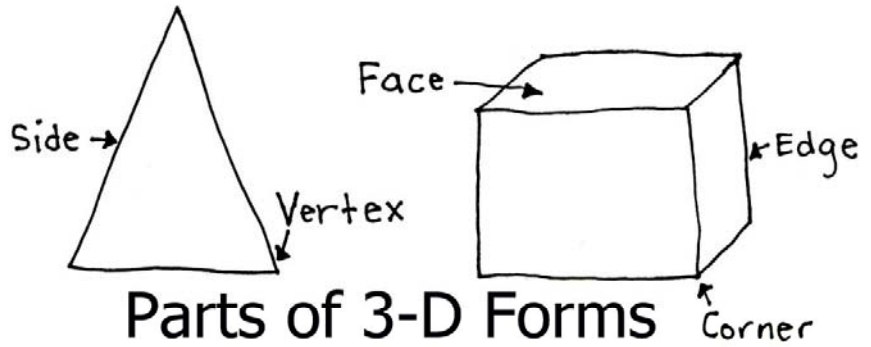

Parts of 3-D Forms

What are the three dimensions?

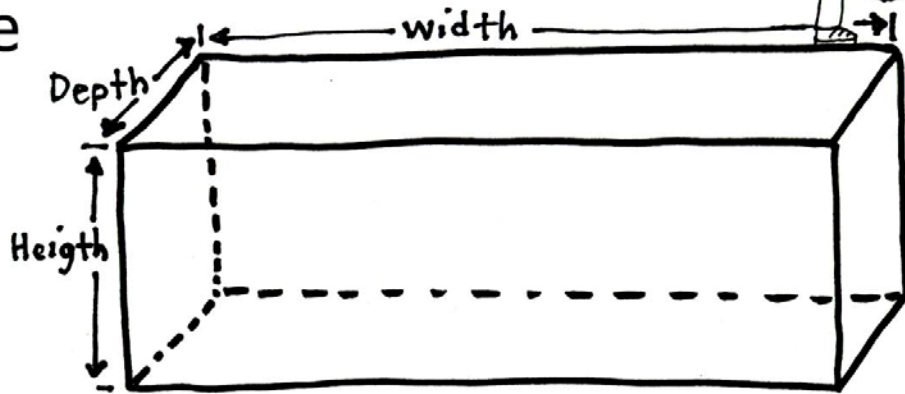

Rectangular Prism

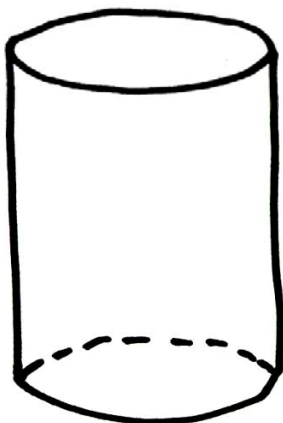

Cylinder

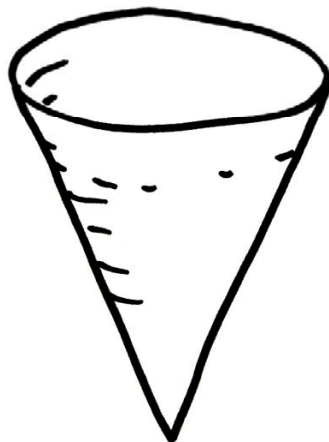

Cone

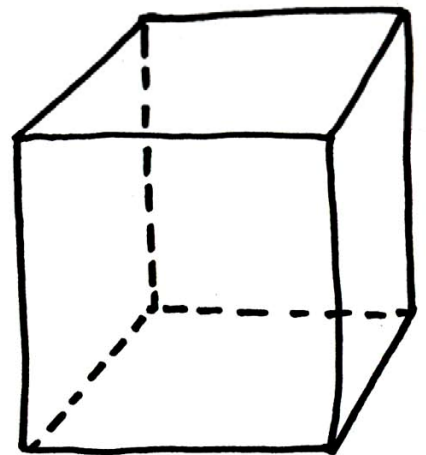

Cube